

**(D)** *Montageanleitung*

**(NL)** *Handleiding voor de montage*

**(TR)** *Montaj talimatı*

**(FR)** *Notice de montage*

**(CZ)** *Montážní návod*

**(HU)** *Szerelési útmutató*

**(GB)** *Assembly instructions*

**(PL)** *Instrukcja montażu*

**(RU)** *Инструкция по монтажу*

**(IT)** *Istruzioni di montaggio*

**(SK)** *Návod na montáž*

**(RO)** *Instrucțiuni de montaj*

Name • Nom • Nome • Naam • Nazwa • Иméно •  
Názov • Név • Denumire • Isim • Название

Nr. • No. • N° • Номер • Ć • Sz

Typ • Type • Tip • Típus • Tipo • Тип

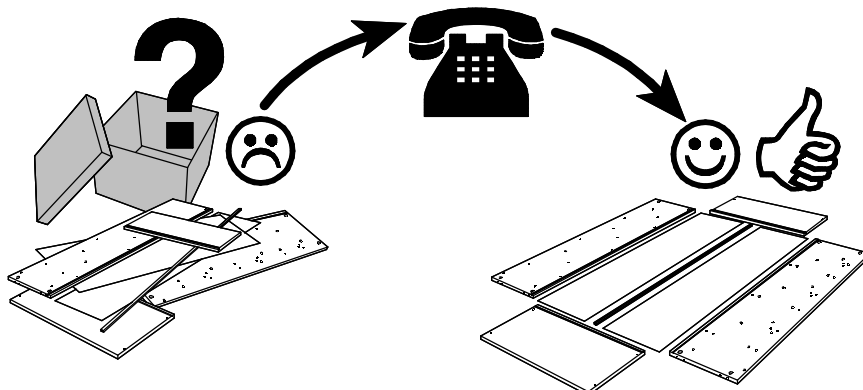
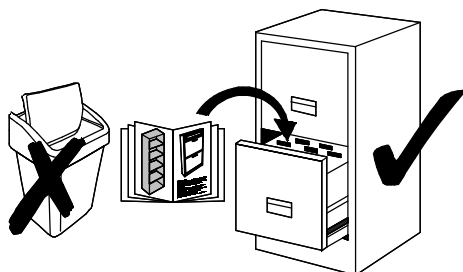

<b>A</b> 12 x  Ø8 x 35	<b>Aj</b> 4 x  Ø5 x 20	<b>Ba</b> 8 x  Ø6,3 x 12	<b>C</b> 4 x  2 mm	<b>Ce</b> 4 x  fk.9	<b>Ea</b> 10 x  Ø3,5 x 15
<b>Eo</b> 1 x  Ø4,0 x 60	<b>Fa</b> 1 x  3 mm	<b>Fb</b> 1 x  3 mm	<b>G</b> 12 x  L - 34	<b>Ga</b> 12 x  Ø15 x 11	<b>Hc</b> 6 x  Ø5 x 50
<b>I</b> 50 x  Ø1,2 x 20	<b>Ib</b> 1 x  45 x 20 x 16	<b>K</b> 4 x  20 x 20 x 16	<b>Kc</b> 1 x  20 x 42 x 70	<b>N</b> 12 x  Ø5 / Ø5	<b>Of</b> 2 x  37 x 164

<b>Ec</b> 2 x  Ø3,5 x 35	<b>Pc</b> 2 x  Ø34 x 29
-----------------------------------	----------------------------------





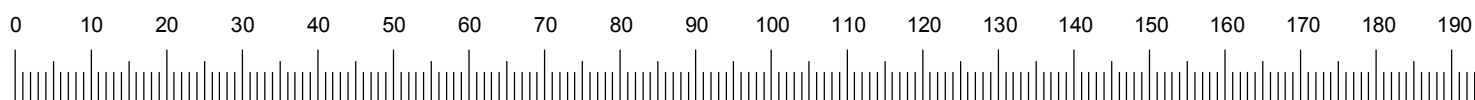
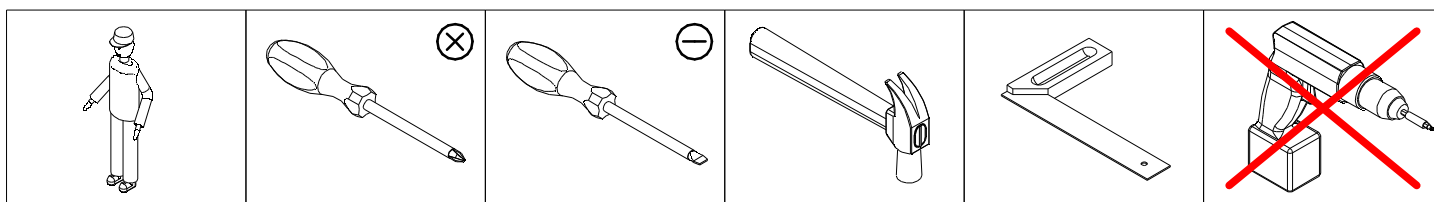

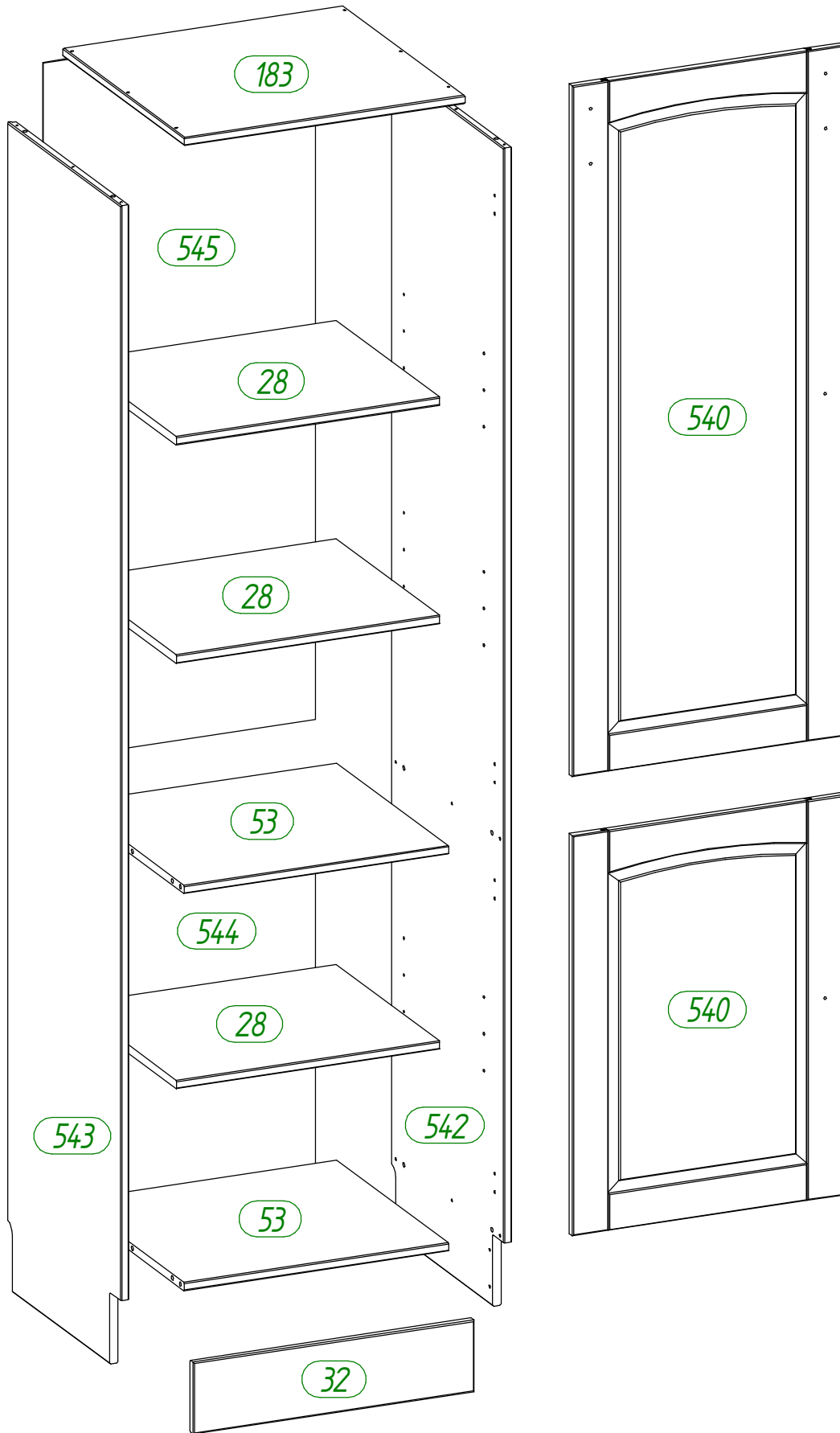
<b>Dd</b> 2 x  M4 x 20	<b>Od</b> 2 x  Ø30 x 27 - M4
---------------------------------	---------------------------------------

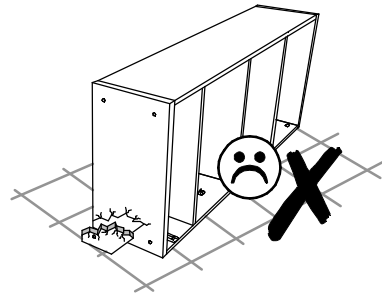
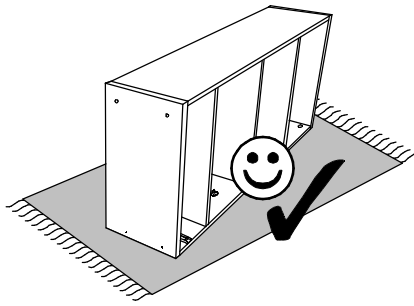





<b>A</b>	4 x	<b>Ba</b>	4 x	<b>C</b>	4 x	<b>G</b>	12 x	<b>K</b>	4 x
									
Ø8 x 35		Ø6,3 x 12		2 mm		L - 34		20 x 20 x 16	

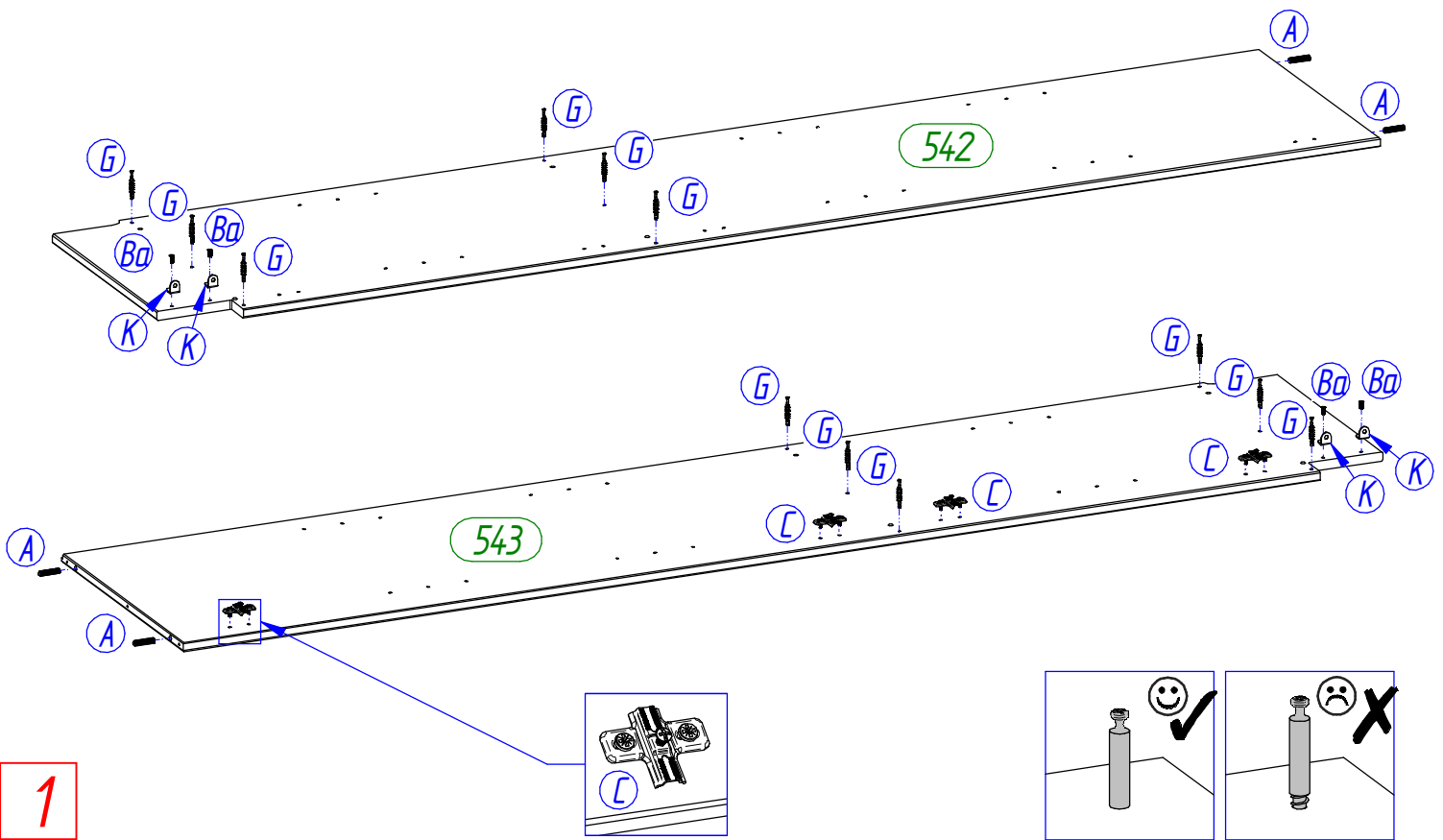

1

<b>A</b>	8 x
	
Ø8 x 35	

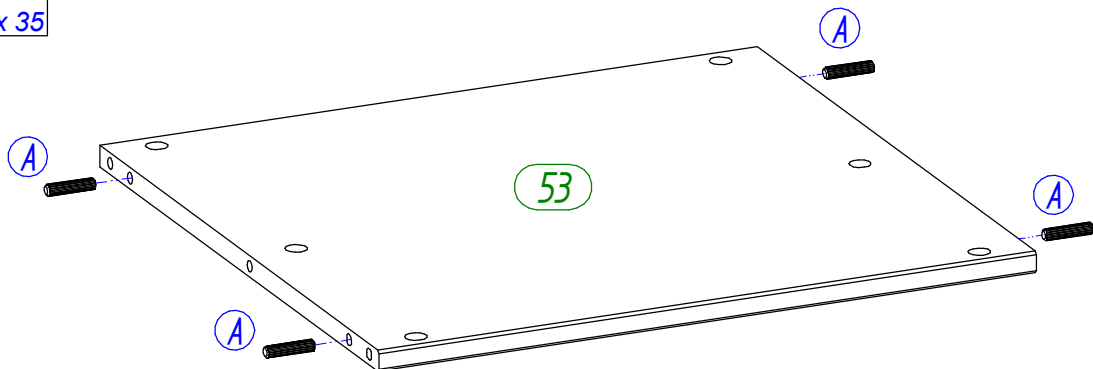

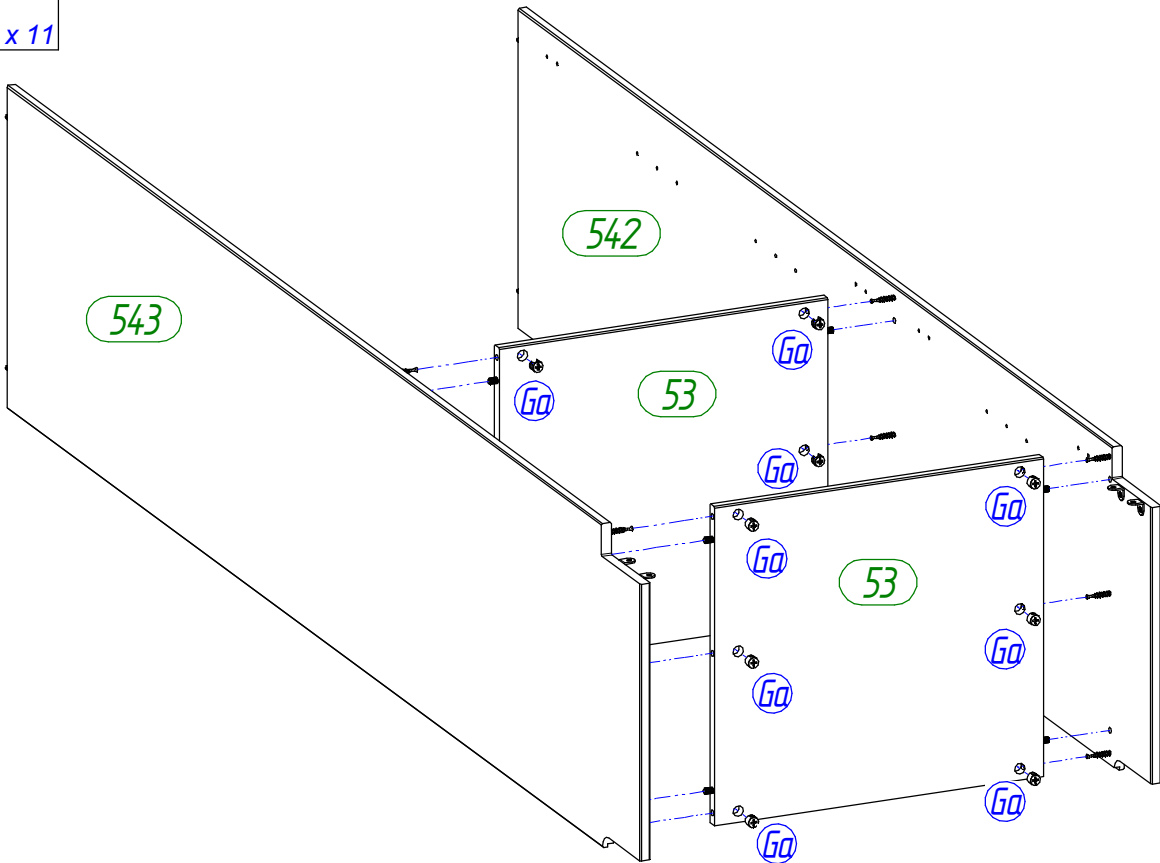

2 x2

**Ga** 12 x  
  
 Ø15 x 11



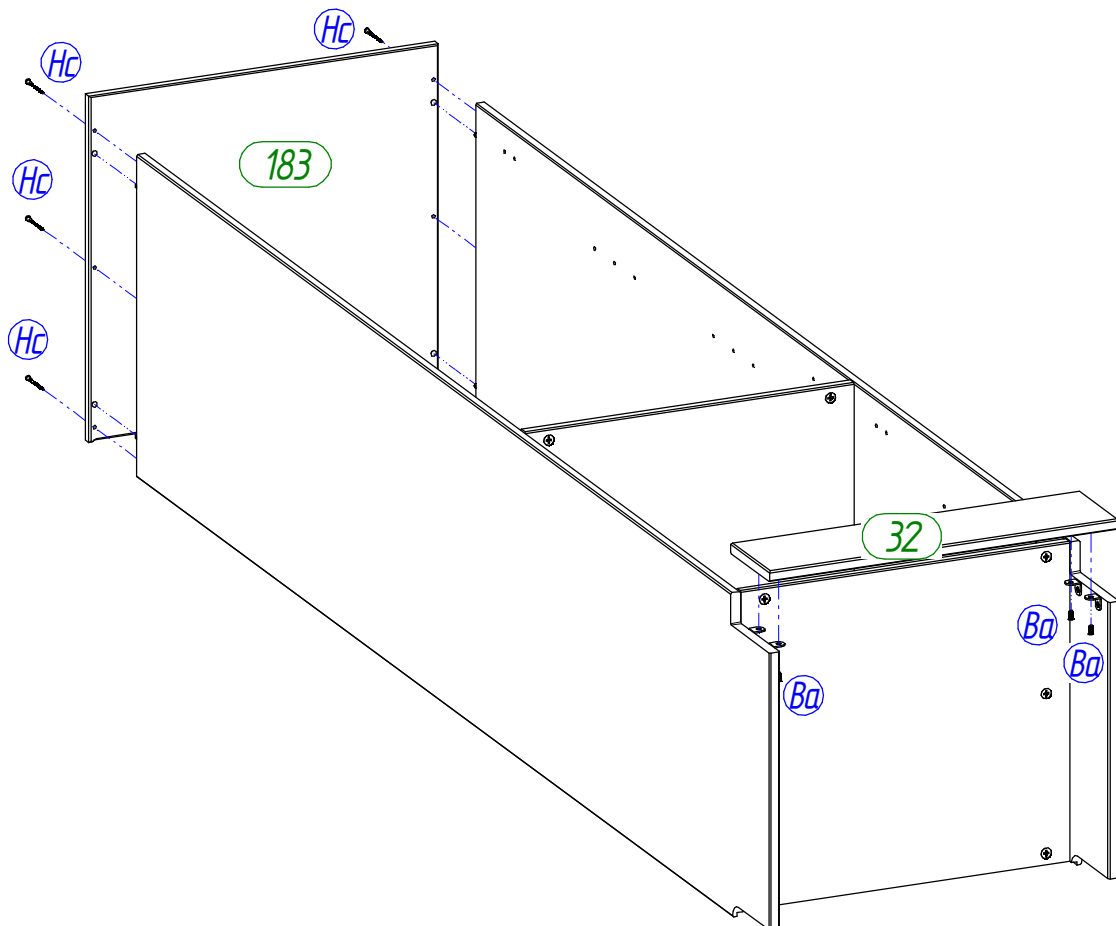

**3**

**Ba** 4 x  Ø6,3 x 12  
**Fb** 1 x  3 mm  
**Hc** 6 x  Ø5 x 50



**4**

<b>I</b>	48 x	<b>lb</b>	1 x
	$\varnothing 1,2 \times 20$		45 x 20 x 16

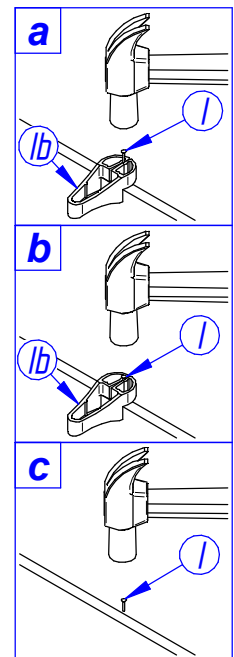
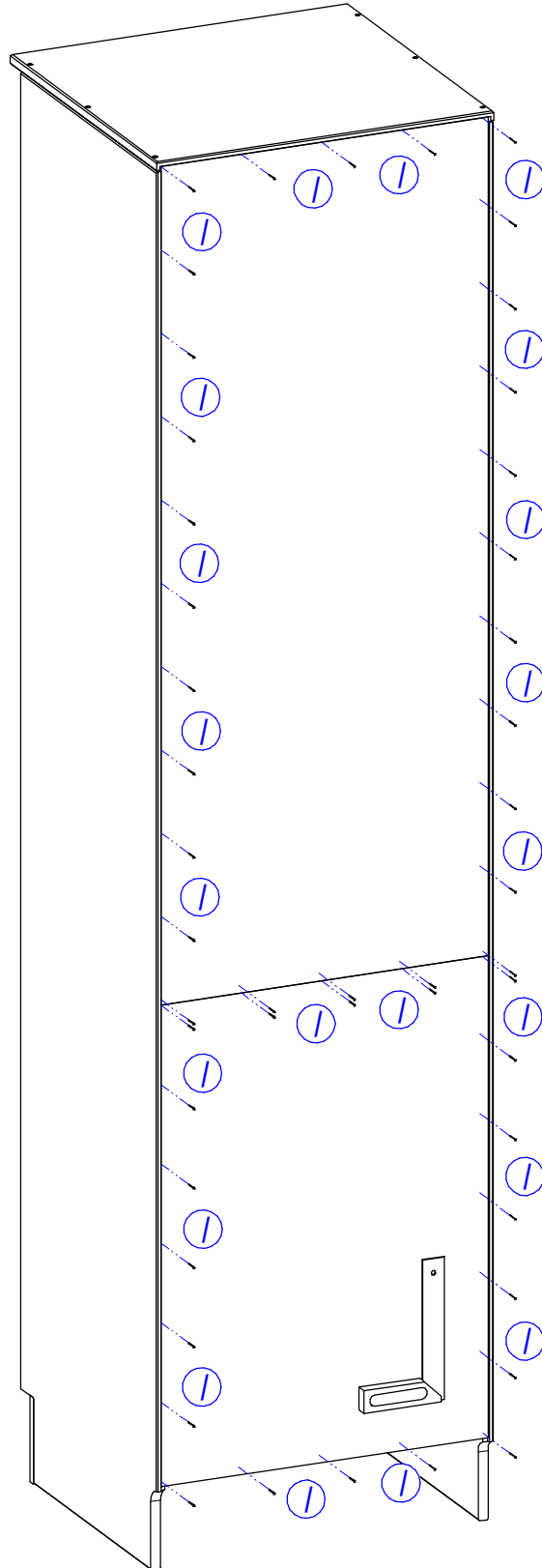

5

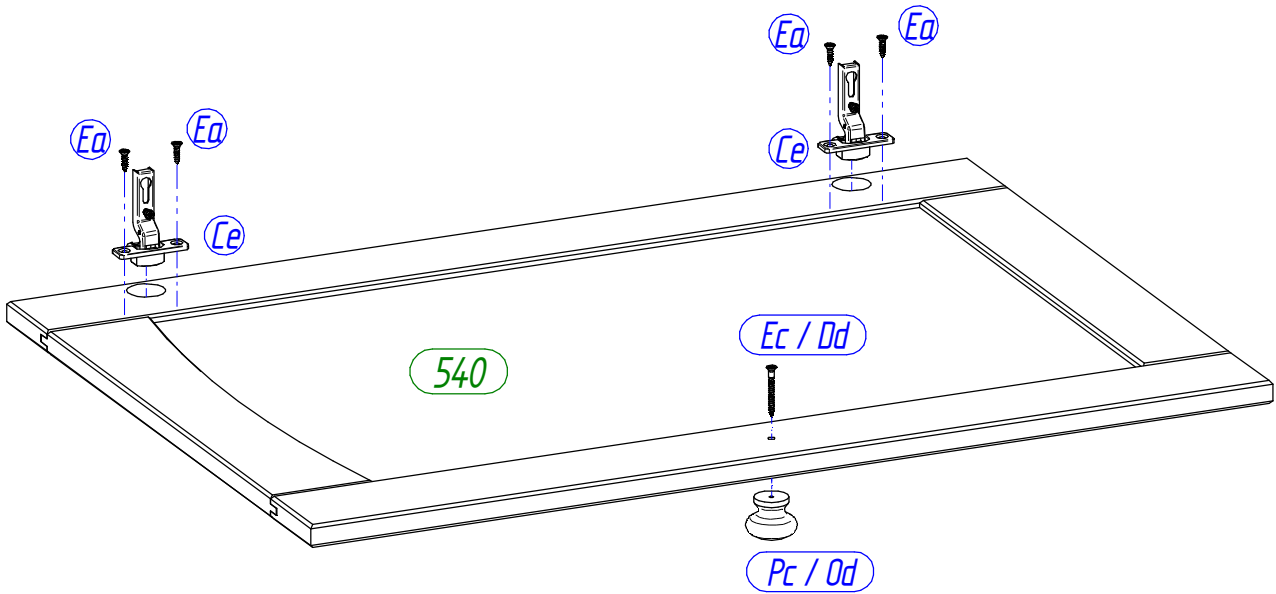
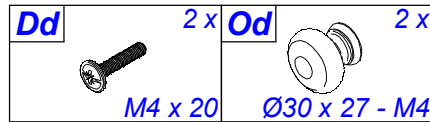
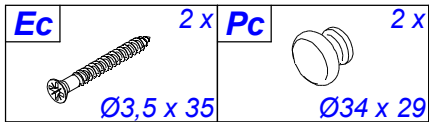
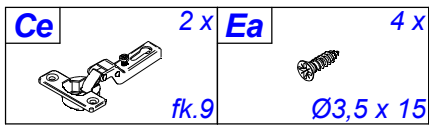

6

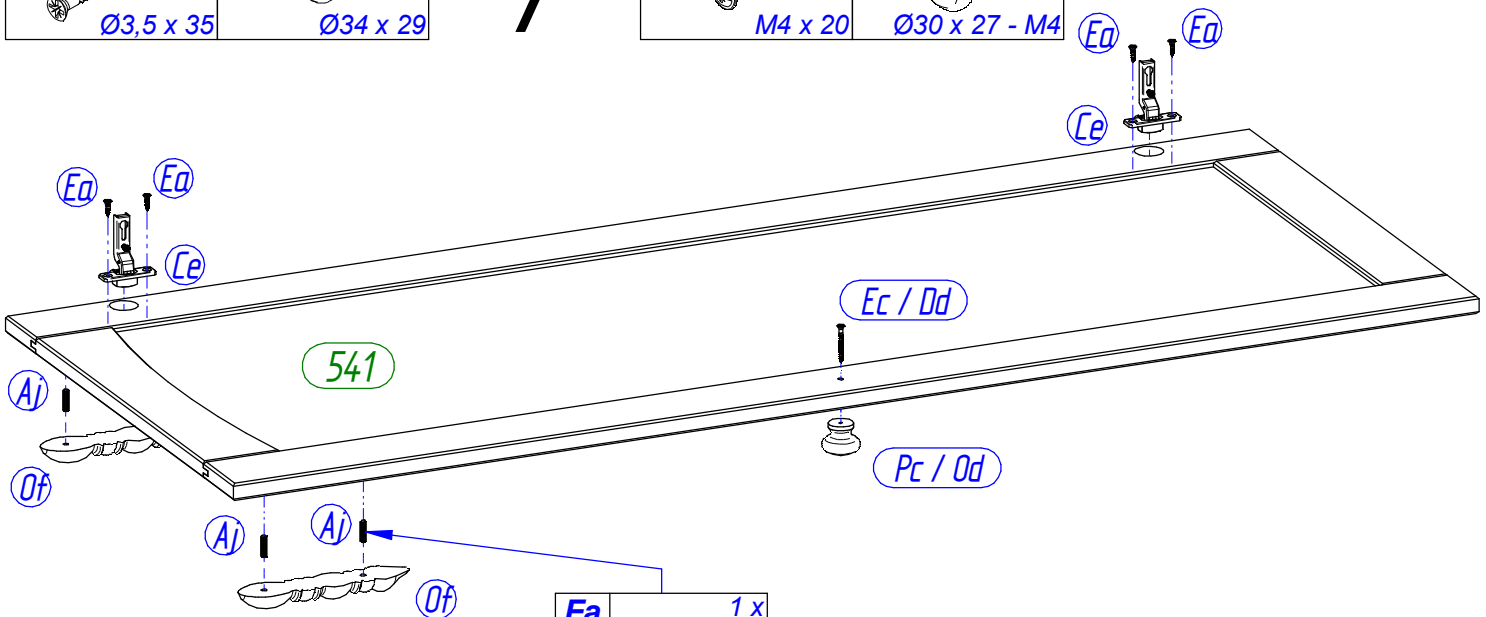
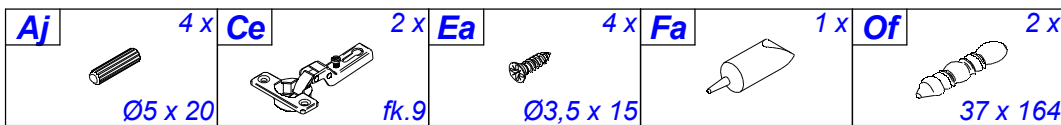

7

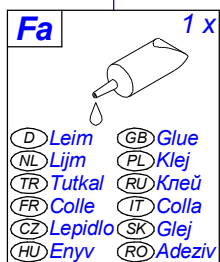
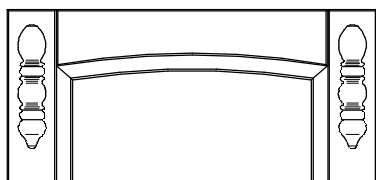

**Achtung • Attention • Attenzione • Opgelet • Uwaga • Pozor • Figyelem • Atenție • Dikkat • Внимание**

(D)	Wandbefestigung dient als Kippschutz – unbedingt anbringen! Bei einigen Wandtypen kann ein Spezialdübel erforderlich sein!
(GB)	The wall fastening serves to prevent tipping – be absolutely sure to mount it! For certain wall types, a special dowel may be necessary!
(NL)	Bevestiging aan de muur dient als kantelbescherming – zeker en vast bevestigen! Bij enkele muurtypes is een speciale plug misschien vereist!
(PL)	Mocowanie do ściany jest jednocześnie zabezpieczeniem przed przewróceniem – koniecznie zamontować! Do niektórych rodzajów ścian konieczne mogą być specjalne wkręty!
(TR)	Duvardaki sabitleme, devrilmeye karşı bir emniyet tedbiridir ve mutlaka monte edilmelidir! Bazı duvar tiplerinde bunun için özel bir dübel gerekli olabilir!
(RU)	Обязательно установите крепление на стене во избежание опрокидывания! Для некоторых типов стен может потребоваться специальный дюбель!
(FR)	La fixation murale sert de protection contre le basculement – à installer impérativement ! Pour certains types de murs il faut des chevilles spéciales !
(IT)	Il fissaggio alla parete serve da protezione anti-ribaltamento – attaccarla assolutamente! Per alcune strutture di parete può essere necessario un tassello speciale!
(CZ)	Montáž na stěnu slouží jako ochrana proti převrnutí – bezpodmínečně umístěte! U některých typů stěn může být zapotřebí speciální hmoždinka!
(SK)	Upevnenie na stenu slúži ako ochrana proti prevráteniu – bezpodmienečne použite! Pre niektoré druhy stien môže byť potrebná špeciálna hmoždinka!
(HU)	A terméket a falhoz kel rögzíténi, különben az felborulhat! Egyes faltípusoknál speciális tiplít kell használni!
(RO)	Sistemul de fixare la perete servește ca protecție la răsturnarede montat obligatoriu! Pentru unele tipuri de pereți este posibil să fie necesar un diblu special!

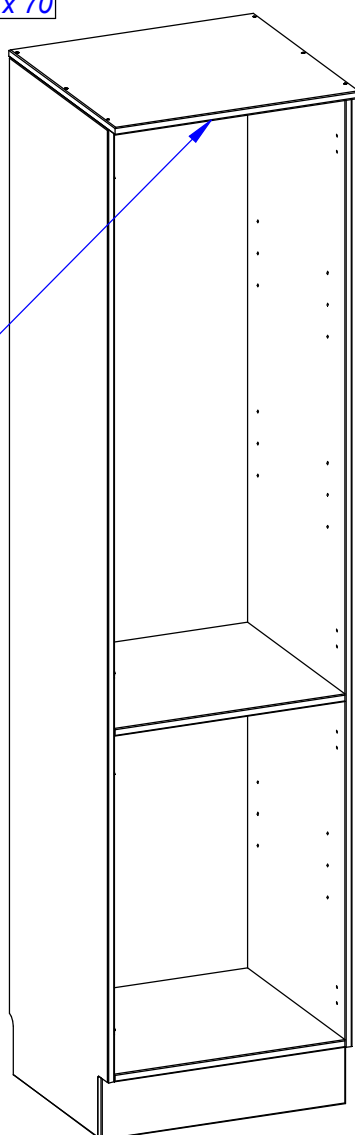
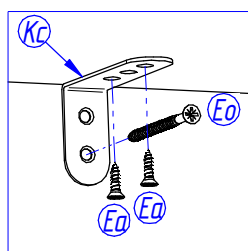
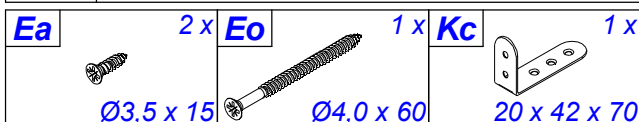



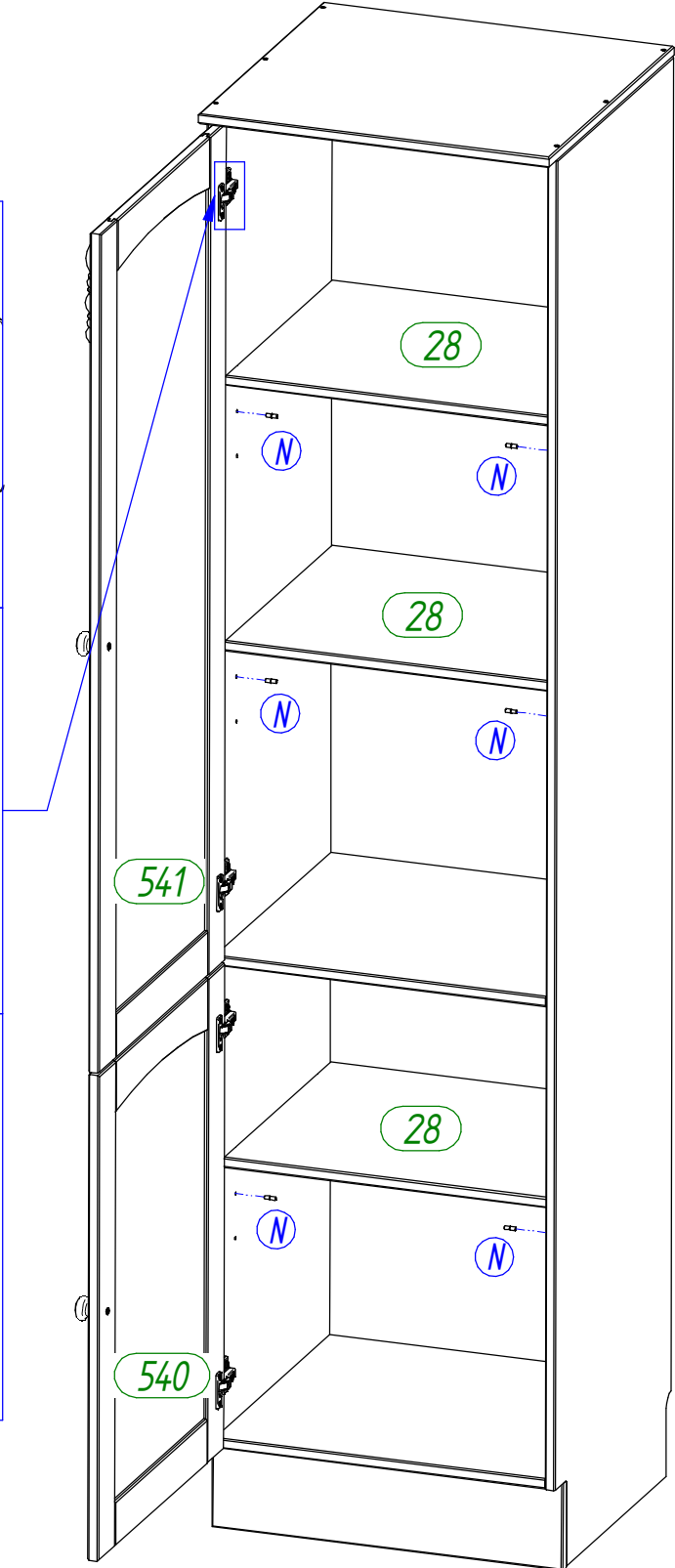
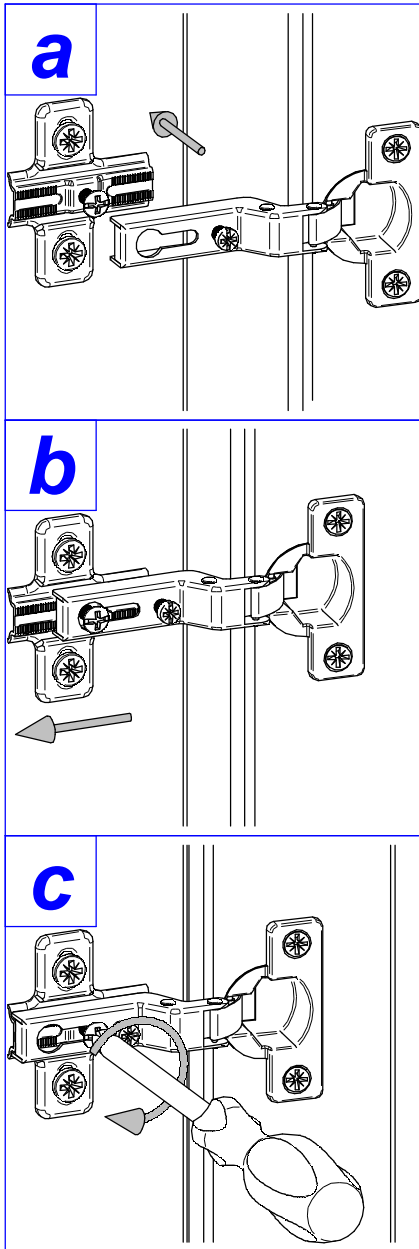
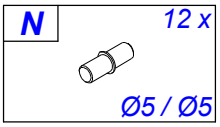

**! Achtung • Attention • Attenzione • Opgelet • Uwaga • Pozor • Figyelem • Atenție • Dikkat • Внимание !**

<b>(D)</b>	Türen einstellen (Scharniere justieren)
<b>(GB)</b>	Adjusting the doors (adjusting the hinges)
<b>(NL)</b>	Deuren instellen (scharnieren afstellen)
<b>(PL)</b>	Nastawić drzwi (wyrównać zawiasy)
<b>(TR)</b>	Kapıların ayarlanması (menteşelerin seviye ayarı)
<b>(RU)</b>	Регулировка дверей (регулировка шарнира)
<b>(FR)</b>	Régler les portes (ajuster les charnières)
<b>(IT)</b>	Sistemare le porte (regolare le cerniere)
<b>(CZ)</b>	Vyrovnejte dvířka (seřídte závěsy)
<b>(SK)</b>	Nastavenie dverí (nastavenie závesov)
<b>(HU)</b>	Állítsa be az ajtókat (állítsa be a zsanérokat)
<b>(RO)</b>	Reglare ușii (ajustare balamale)

