

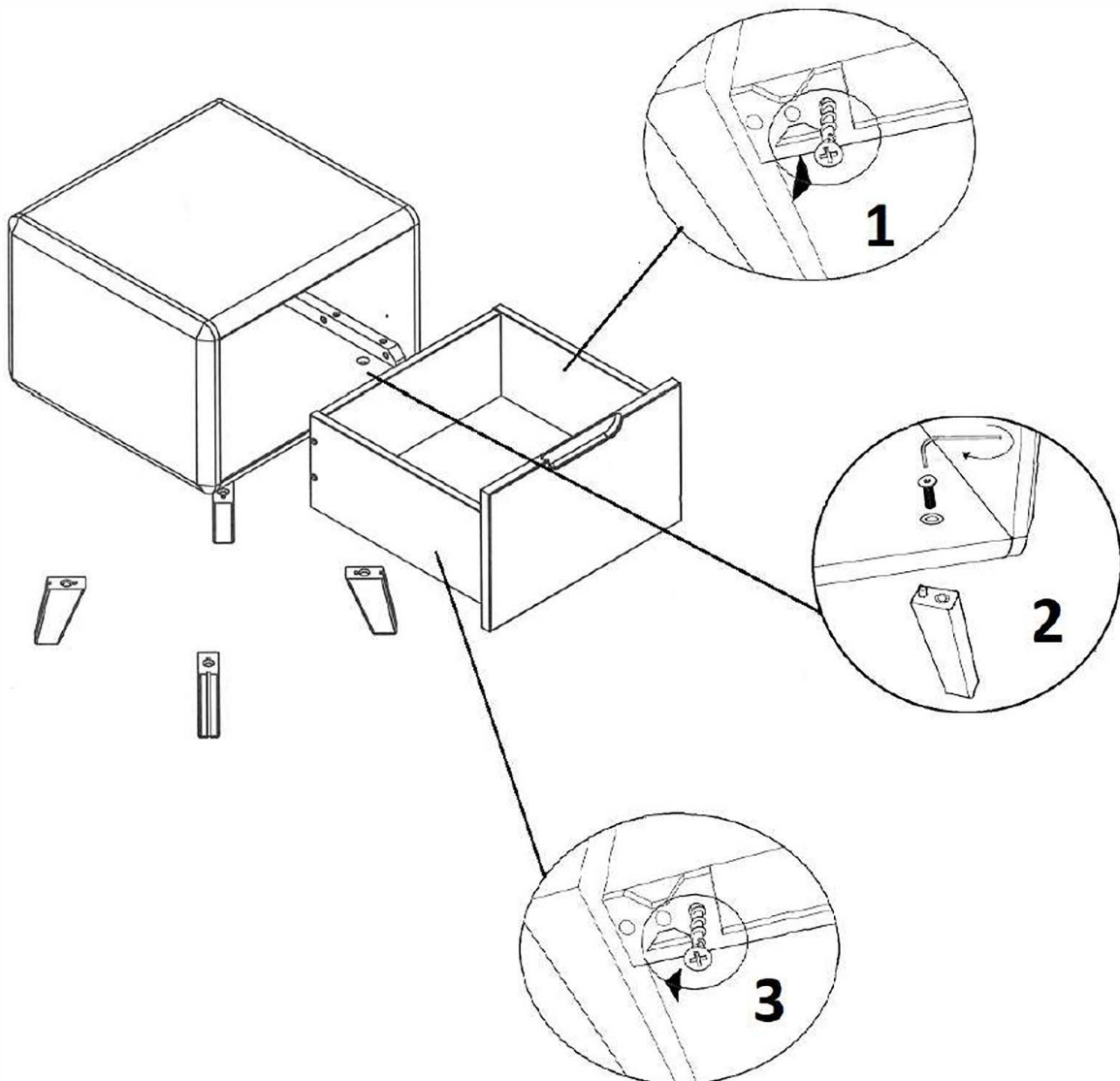

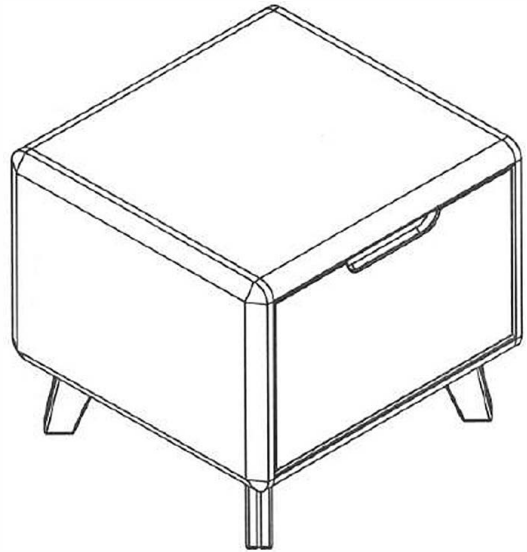

49249038

450x420x400

1. Opening the drawer and unscrewing the screw
2. Leg placement and clamping
3. Replacing the drawer and tightening the screw



	M8x40	SW 5 mm
4x	 4x	 1x