

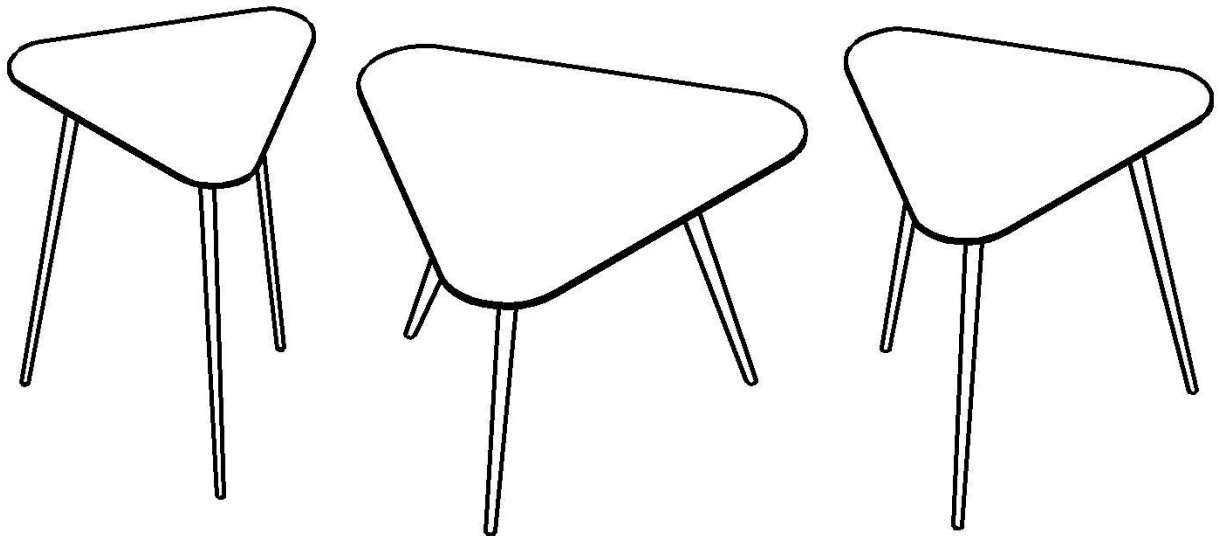

Assembly Instructions

Ref. 1053-16 ,1053-17 & 1053-018



 20 MIN	
--	---

1

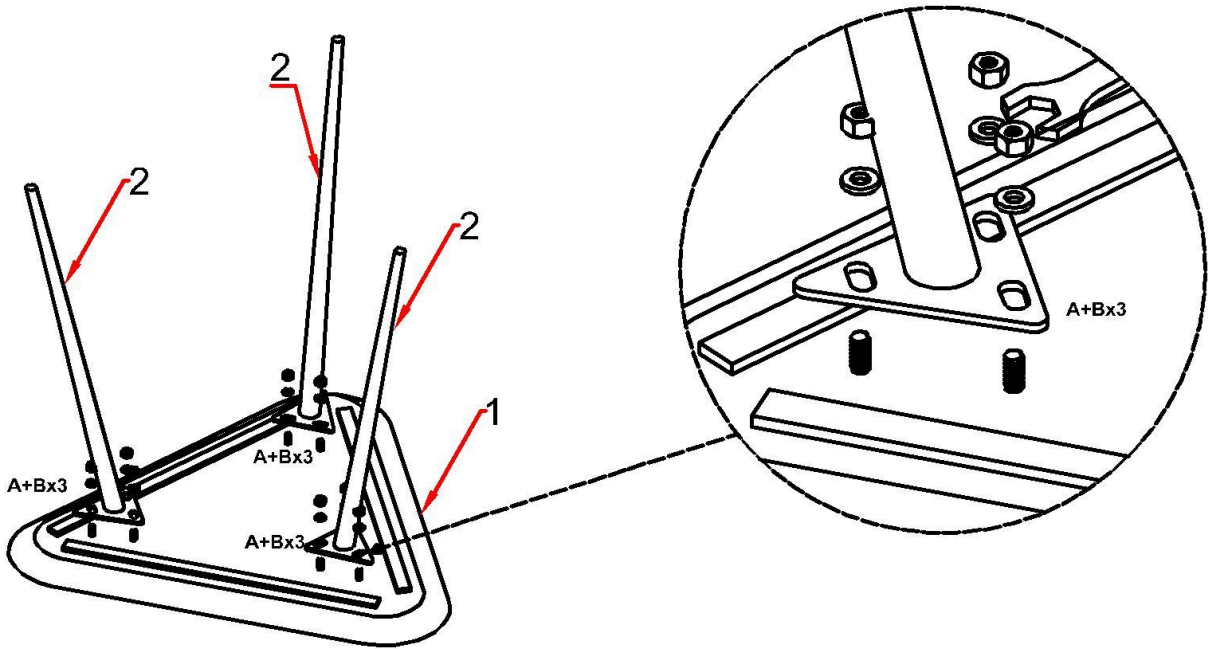

A

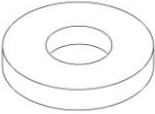
 $\text{Ø}12 \times 20 \text{mm}$ X9

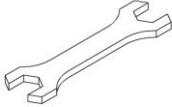
B

 $\text{Ø}4 \times 30 \text{mm}$ X9

C

X1

②

