

# ASSEMBLY INSTRUCTIONS

DESCRIPTION:- MARCH SIDEBOARD

0.25 HOURS

APPROXIMATE ASSEMBLY TIME

2 PERSON ASSEMBLY

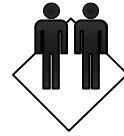

CEILING HEIGHT  
3 M

REQUIRED ASSEMBLY SPACE

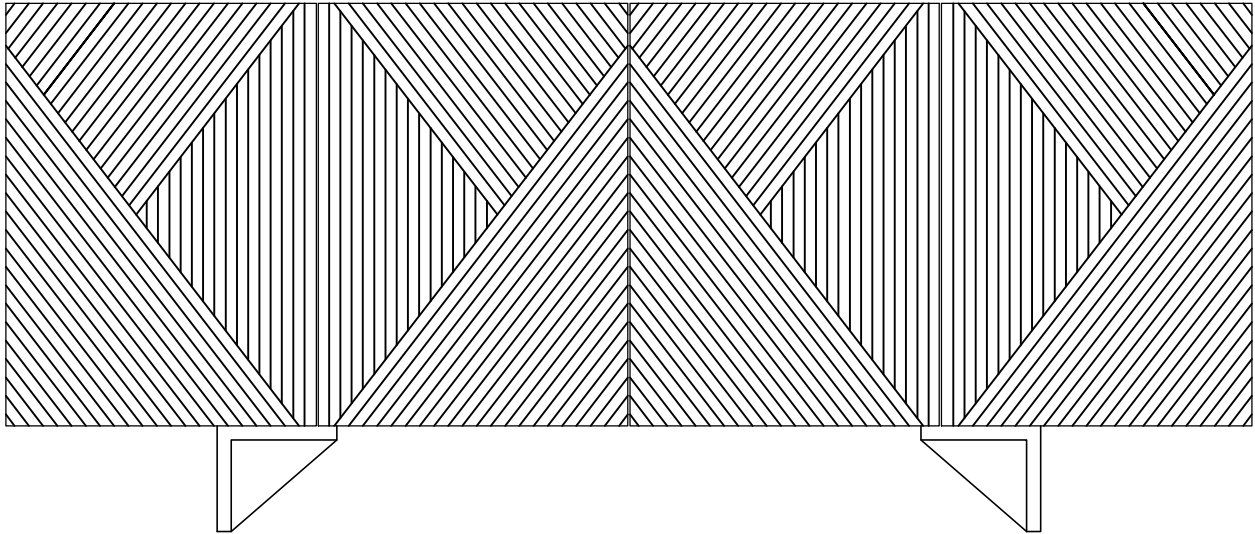

## HARDWARE

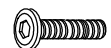

H1 4 Pieces



H2 4 Pieces



H3 4 Pieces

## REQUIRED ASSEMBLY TOOLS

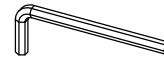

T1 1 Pieces

C

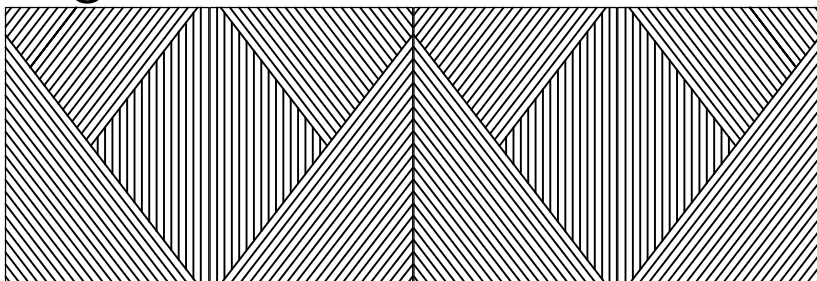

Carcase :- 1 Pieces

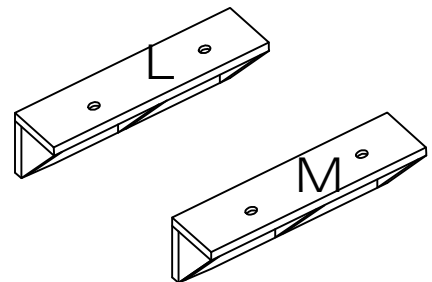

LEGS :- 2 Pieces

## STEP - 1

NOTE:- Each Leg is numbered.  
Please match according to respective markings.

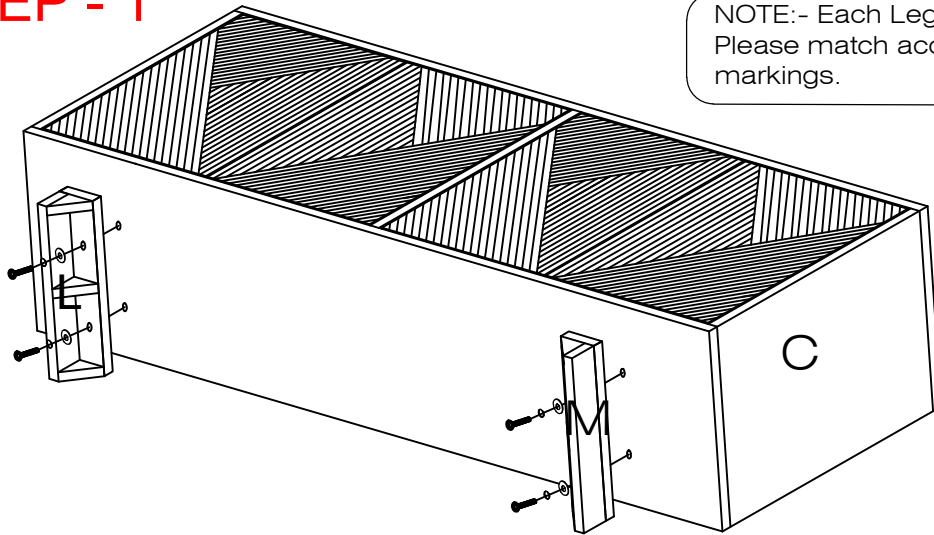



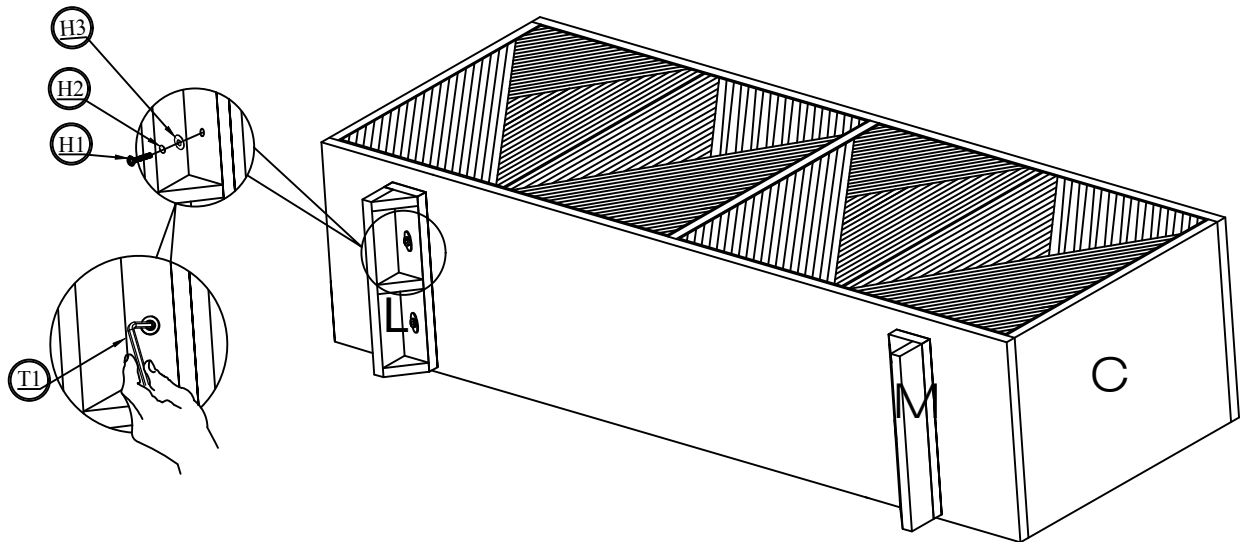



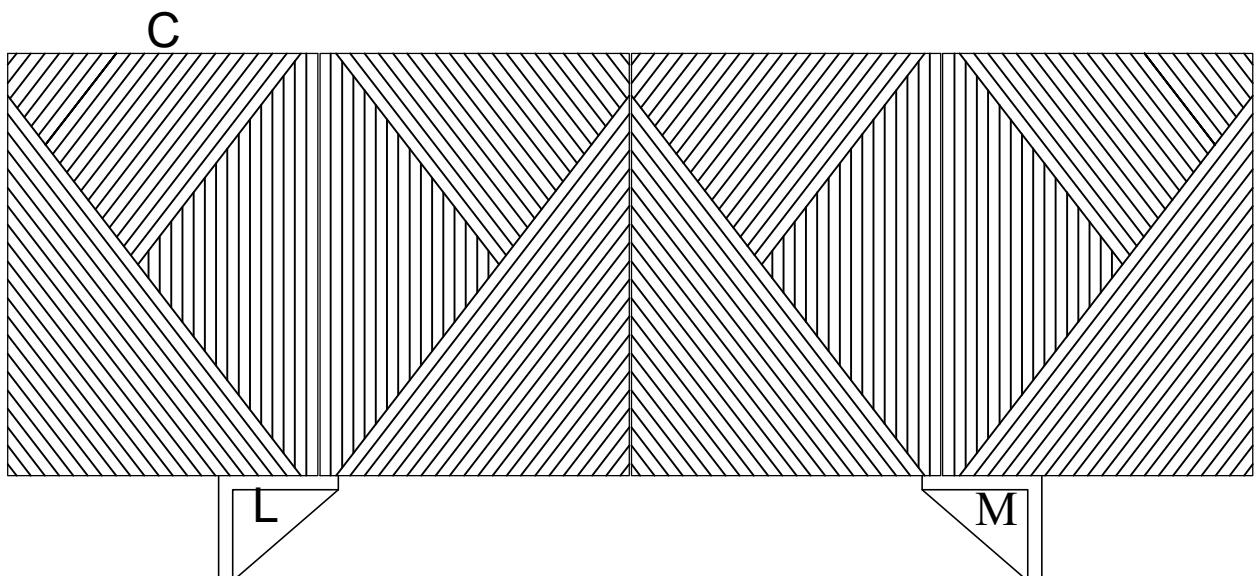





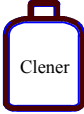

## STEP - 2

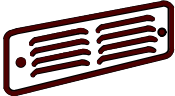

## FINAL PRODUCT



# Care & Maintenance

-   ● Do not put hot items directly on furniture surface.
-   ● Do not clean furniture with harsh cleansers or polish.
-   ● Do not place furniture in direct sunlight.
-   ● Do not place furniture near heating or cooling vents.
-   ● Do not write on furniture without a padded barrier to protect the surface.
-   ● Do not place furniture outside. For indoor use only.
-   ● Dust and pick-up spills using a clean, non-colored, lint-free cloth.
-   ● Stains may be removed with mild soap solution and damp cloth.