

SOLVEI
8141/2500/8300
8100/2500/8142

- | | | | |
|-----------|--|-----------|---|
| D | MONTAGEANLEITUNG
BEDIENUNGSANLEITUNG | GB | ASSEMBLY INSTRUCTIONS
INSTRUCTION MANUAL |
| NL | HANDLEIDING VOOR DE MONTAGE
GEBRUIKSAANWIJZING | PL | INSTRUKCJA MONTAŻU
INSTRUKCJA OBSŁUGI |
| TR | MONTAJ TALIMATI
KULLANIM KLAVUZU | RU | ИНСТРУКЦИЯ ПО МОНТАЖУ
ИНСТРУКЦИЯ ПО ЭКСПЛУАТАЦИИ |
| RO | INSTRUCȚIUNI DE INSTALARE
INSTRUCȚIUNI DE UTILIZARE | IT | ISTRUZIONI DI MONTAGGIO
MANUALE DI ISTRUZIONI |
| FR | NOTICE DE MONTAGE
MANUEL INSTRUCTIONS | SK | MONTÁŽNY NÁVOD
NÁVOD NA POUŽITIE |
| HU | KÖZGYŰLÉS UTASÍTÁSOK
KEZELÉSI UTASÍTÁS | CZ | MONTÁŽNÍ NÁVOD
NÁVOD K POUŽITÍ |
| SI | NAVODILA ZA MONTAŽO
NAVODILA ZA UPORABO | PT | INSTRUÇÕES DE MONTAGEM
MANUAL DO USUÁRIO |
| ES | INSTRUCCIONES DE MONTAJE
MANUAL DEL USUARIO | HR | UPUTE ZA MONTAŽU
UPUTE ZA UPOTREBU |

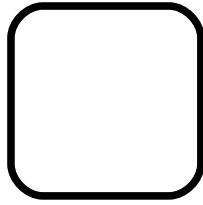

190801





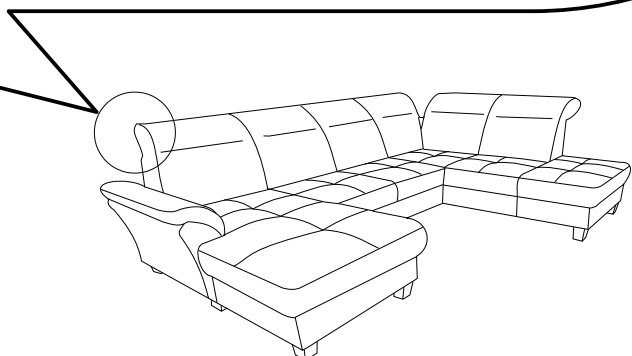
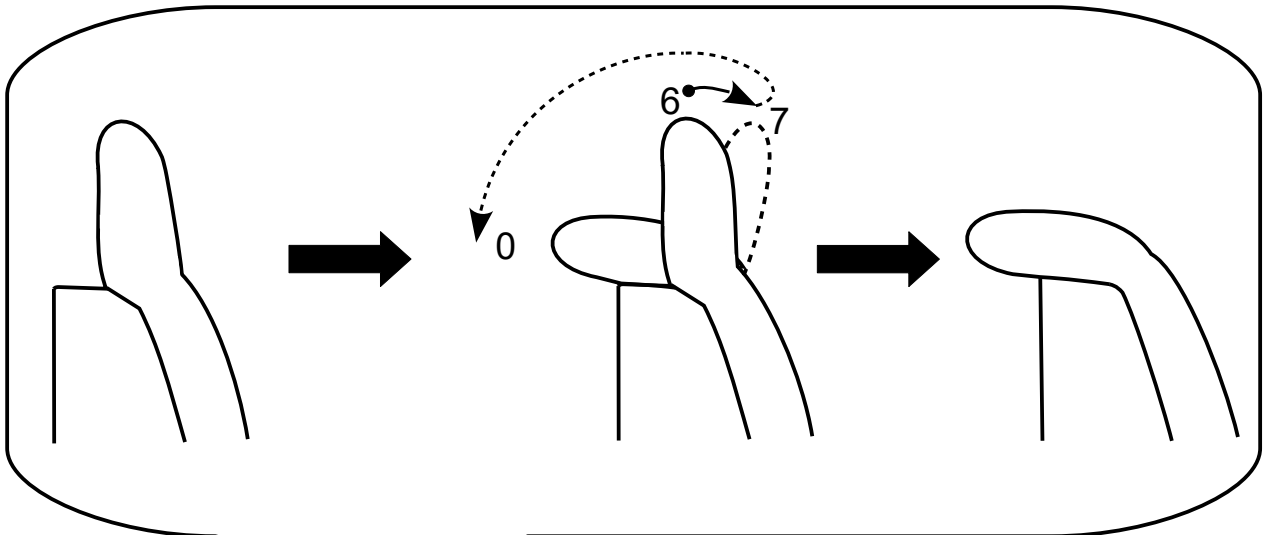
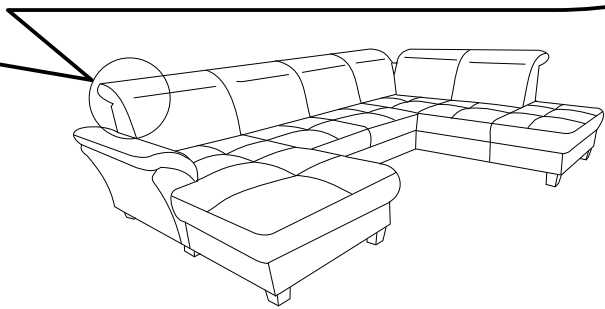
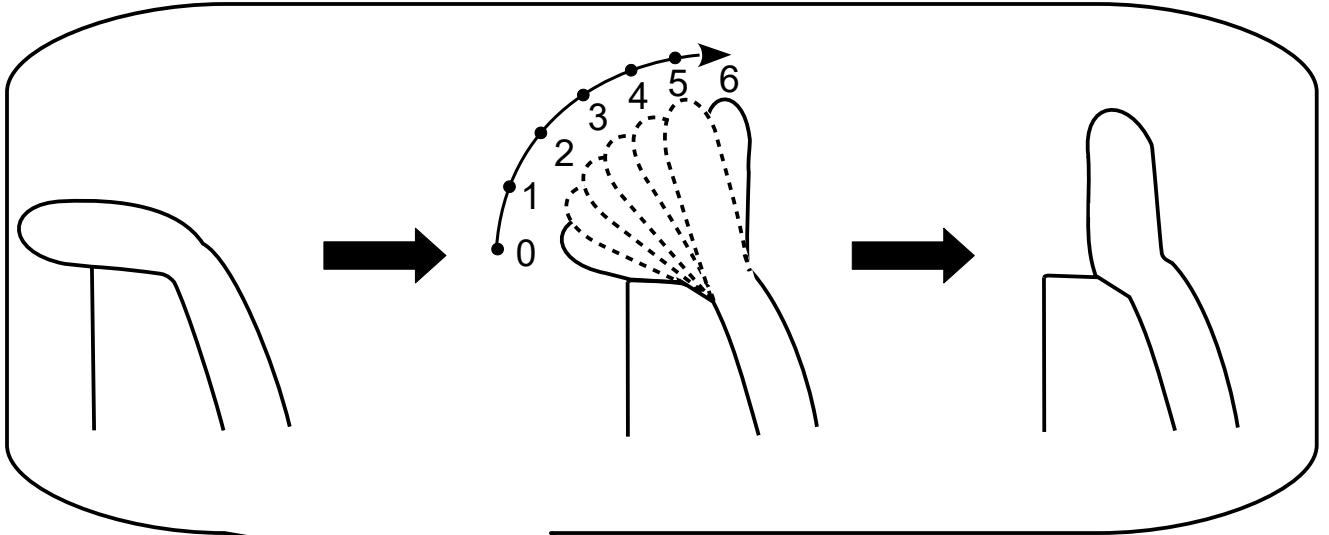

0064



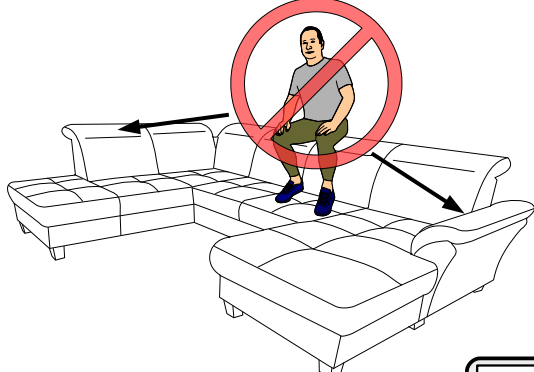





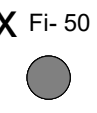

R

L







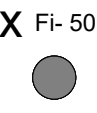

s H- 90  X4	q M8*80  X4
g H- 90  X3	x Fi- 50  X4

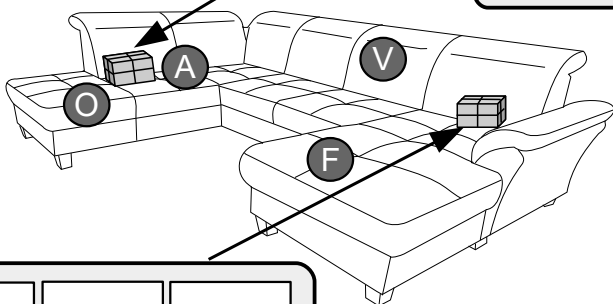
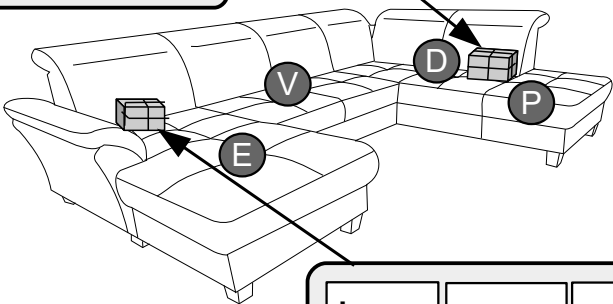
i L- 5  X1	s H- 90  X9	q M8*80  X9	g H- 90  X5	x Fi- 50  X9
--	---	---	---	--





s H- 90  X4	q M8*80  X24
g H- 90  X3	x Fi- 50  X4

[mm]

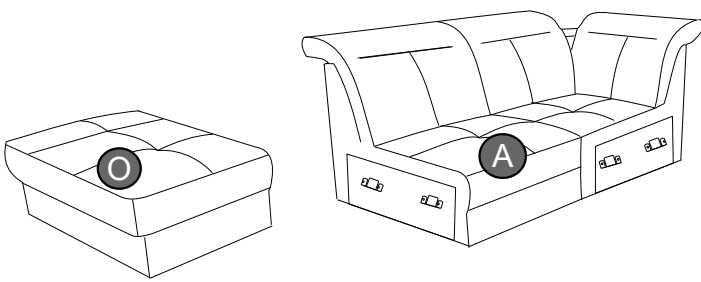
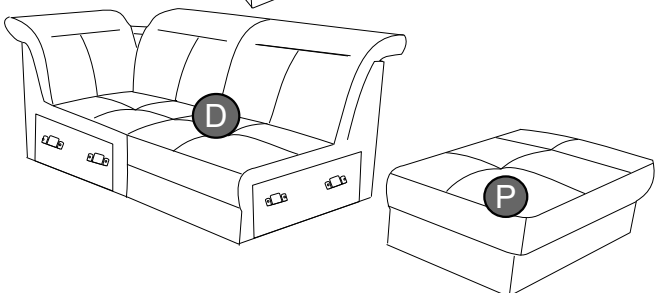
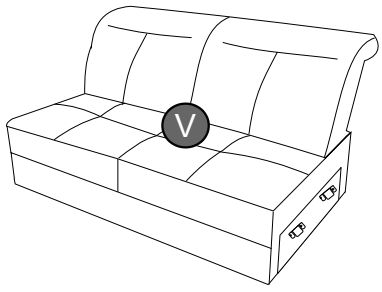
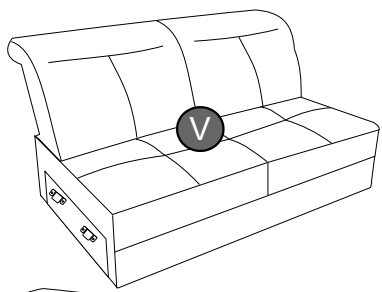
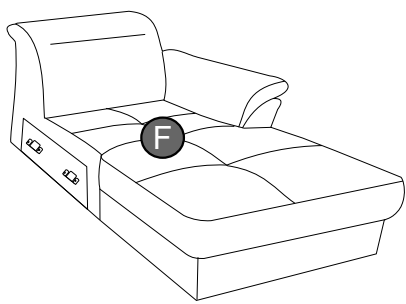
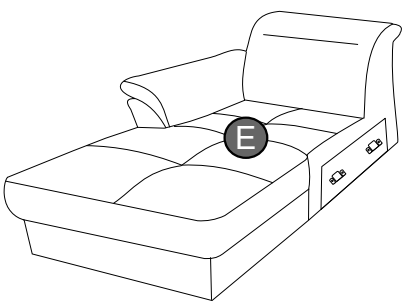





i L- 5  X1	s H- 90  X5	q M8*80  X5	g H- 90  X2	x Fi- 50  X5
--	---	---	---	--

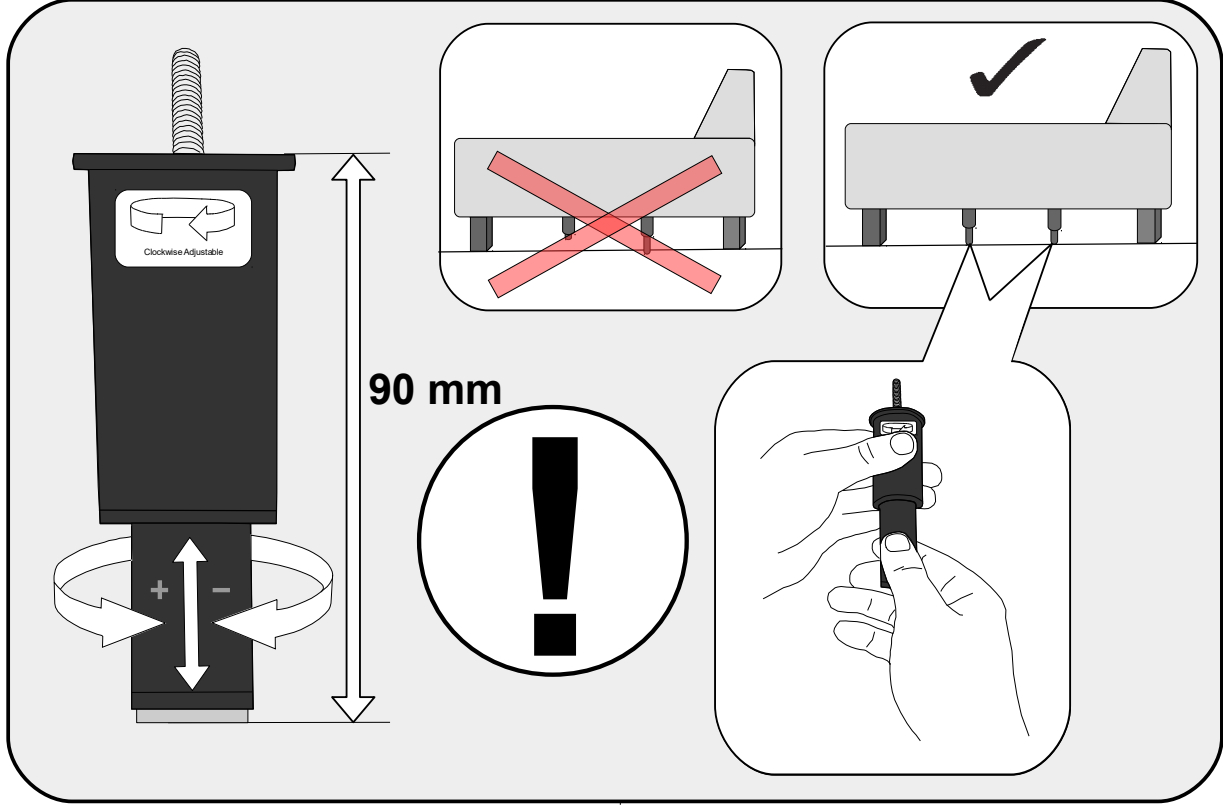
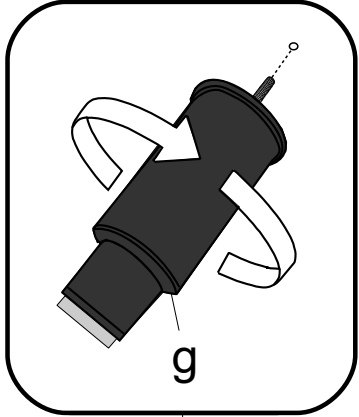
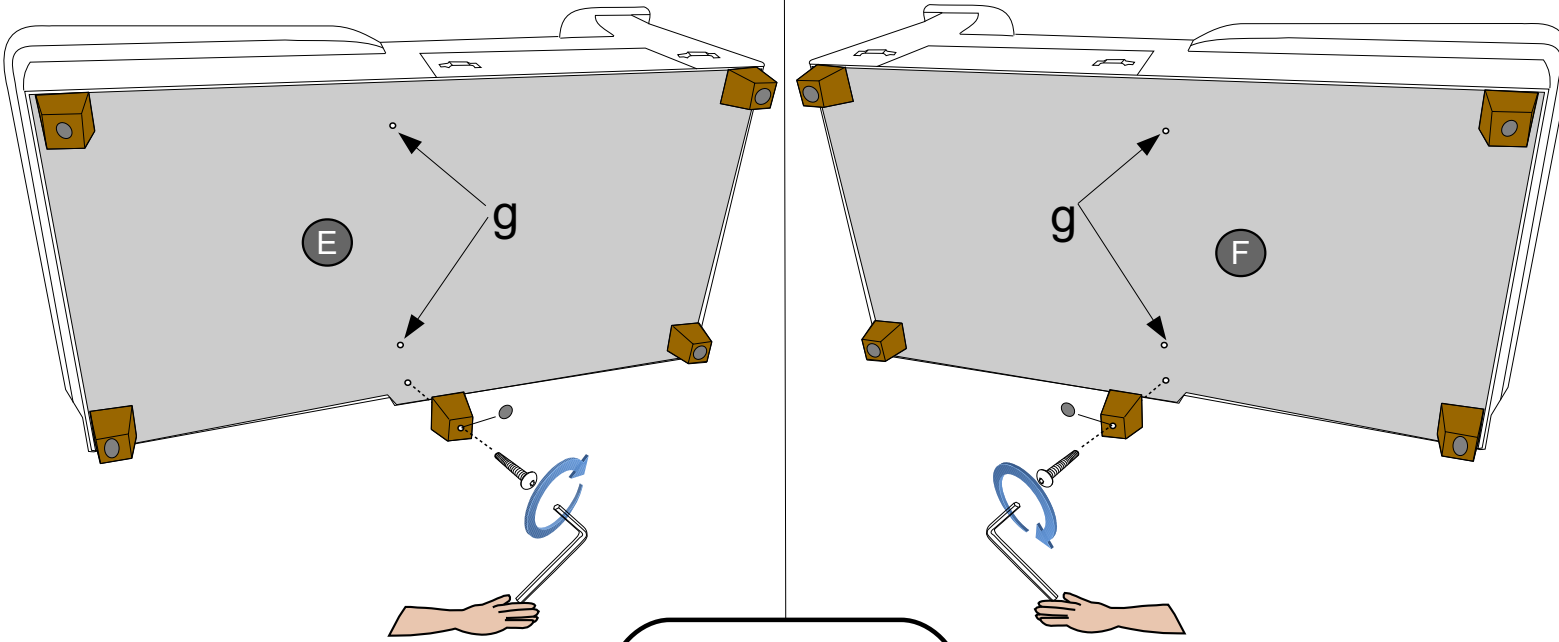





i L-5	s H-90	q M8*80	g H-90	x Fi-50
				
X1	X5	X5	X2	X5

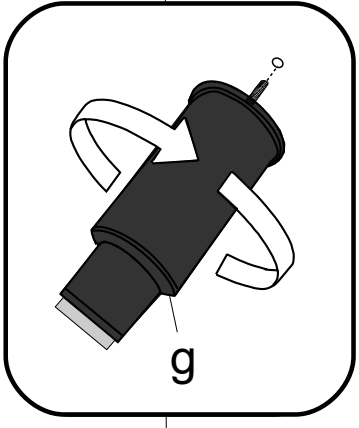
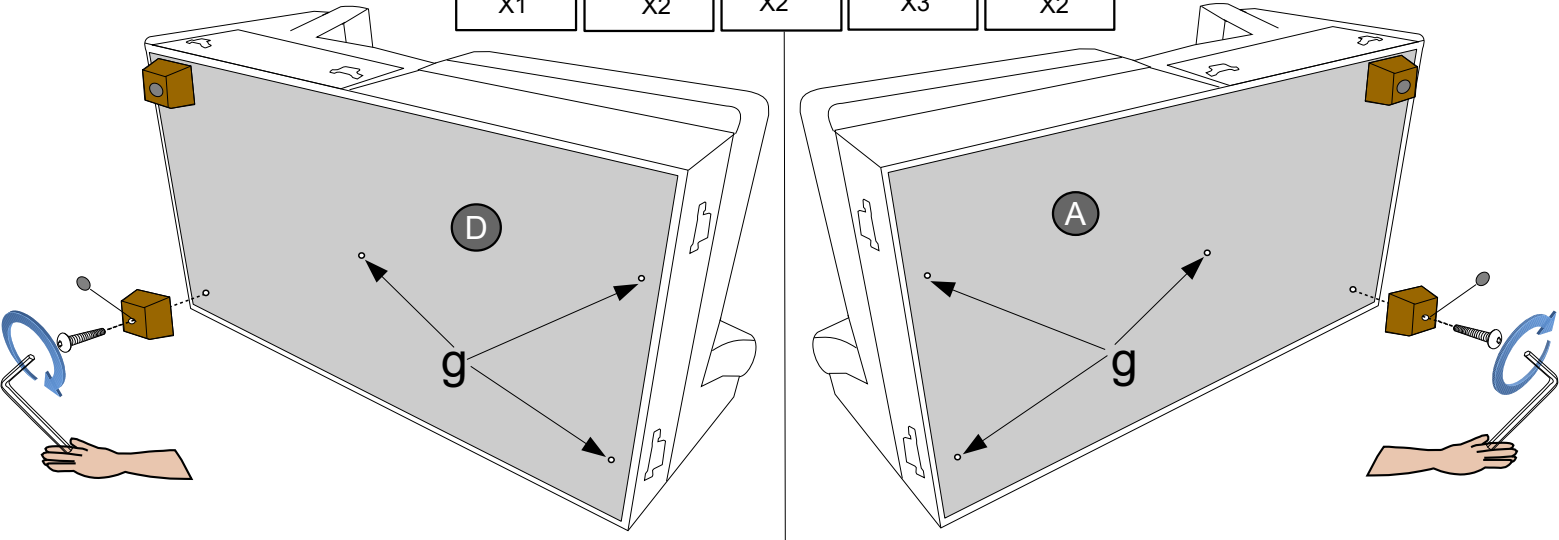

i L-5	s H-90	q M8*80	g H-90	x Fi-50
				
X1	X2	X2	X3	X2



i L-5	s H-90	q M8*80	x Fi-50
			
X1	X2	X2	X2

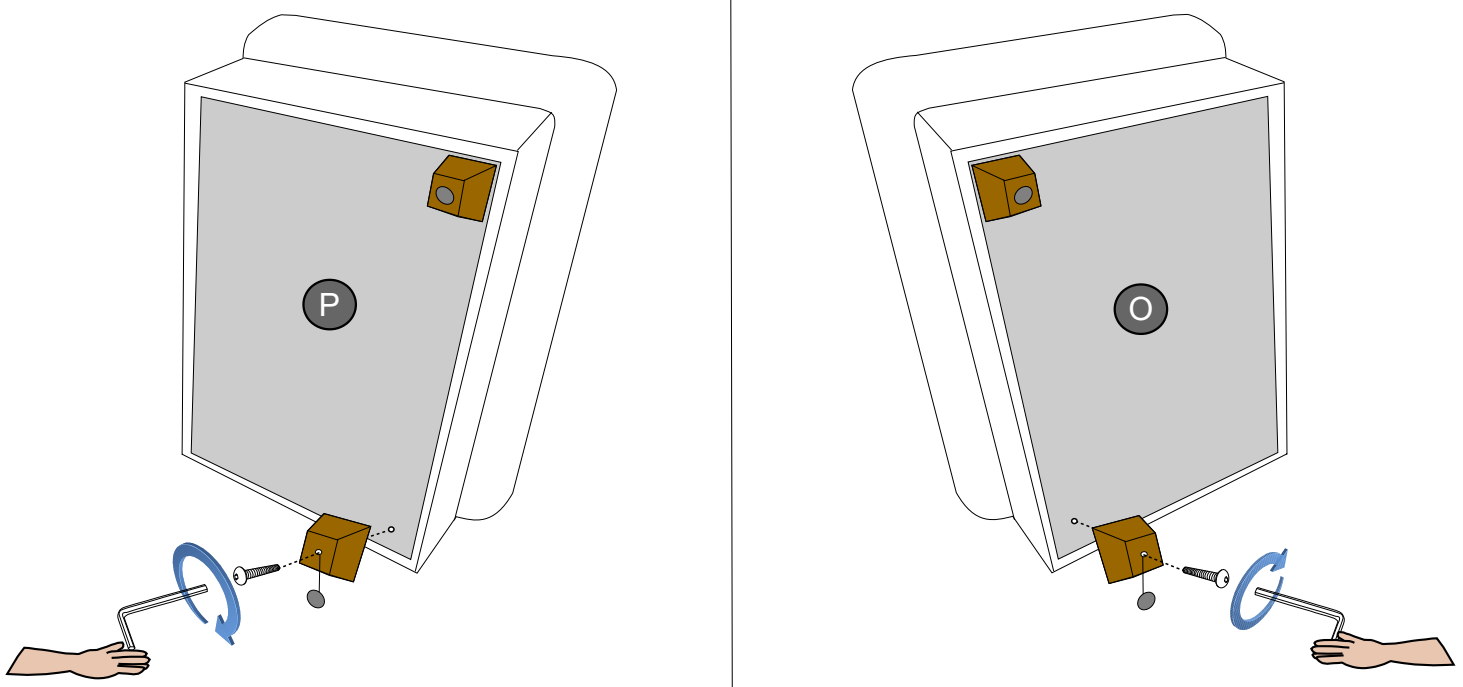

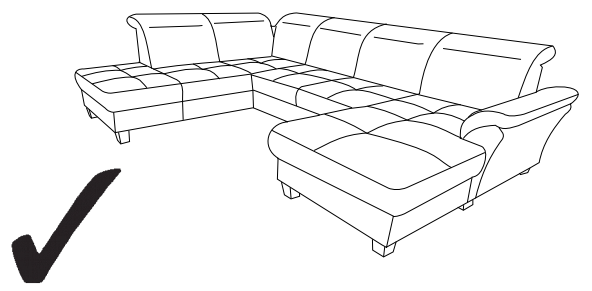
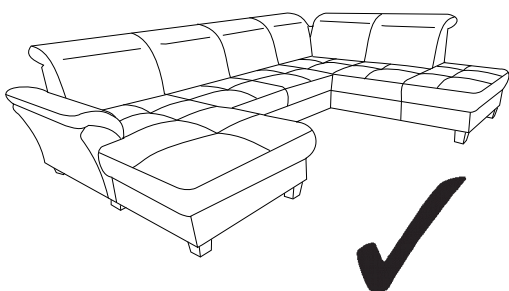
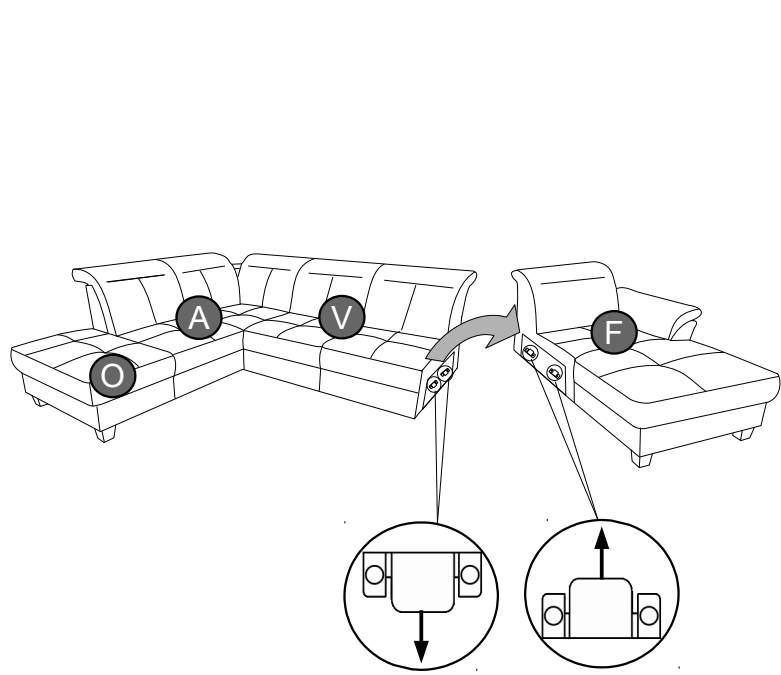
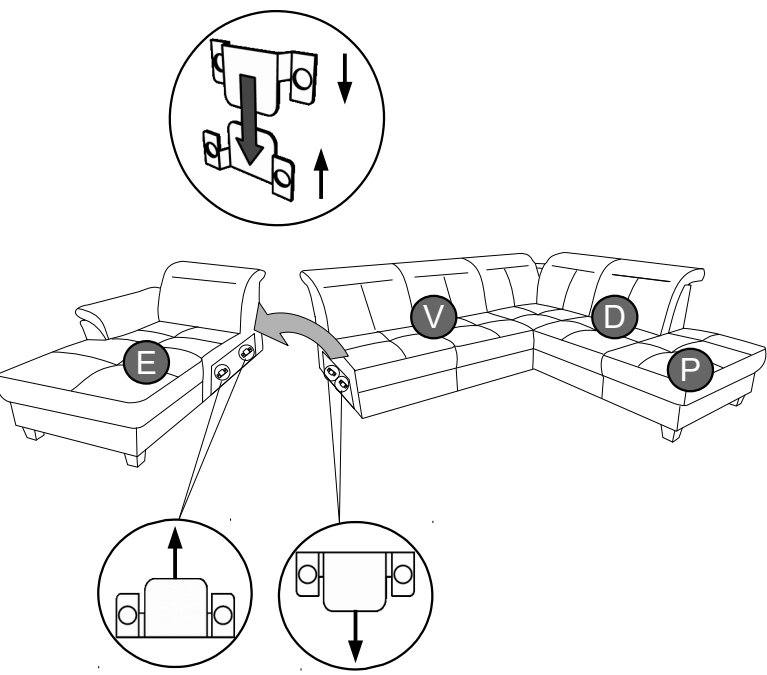
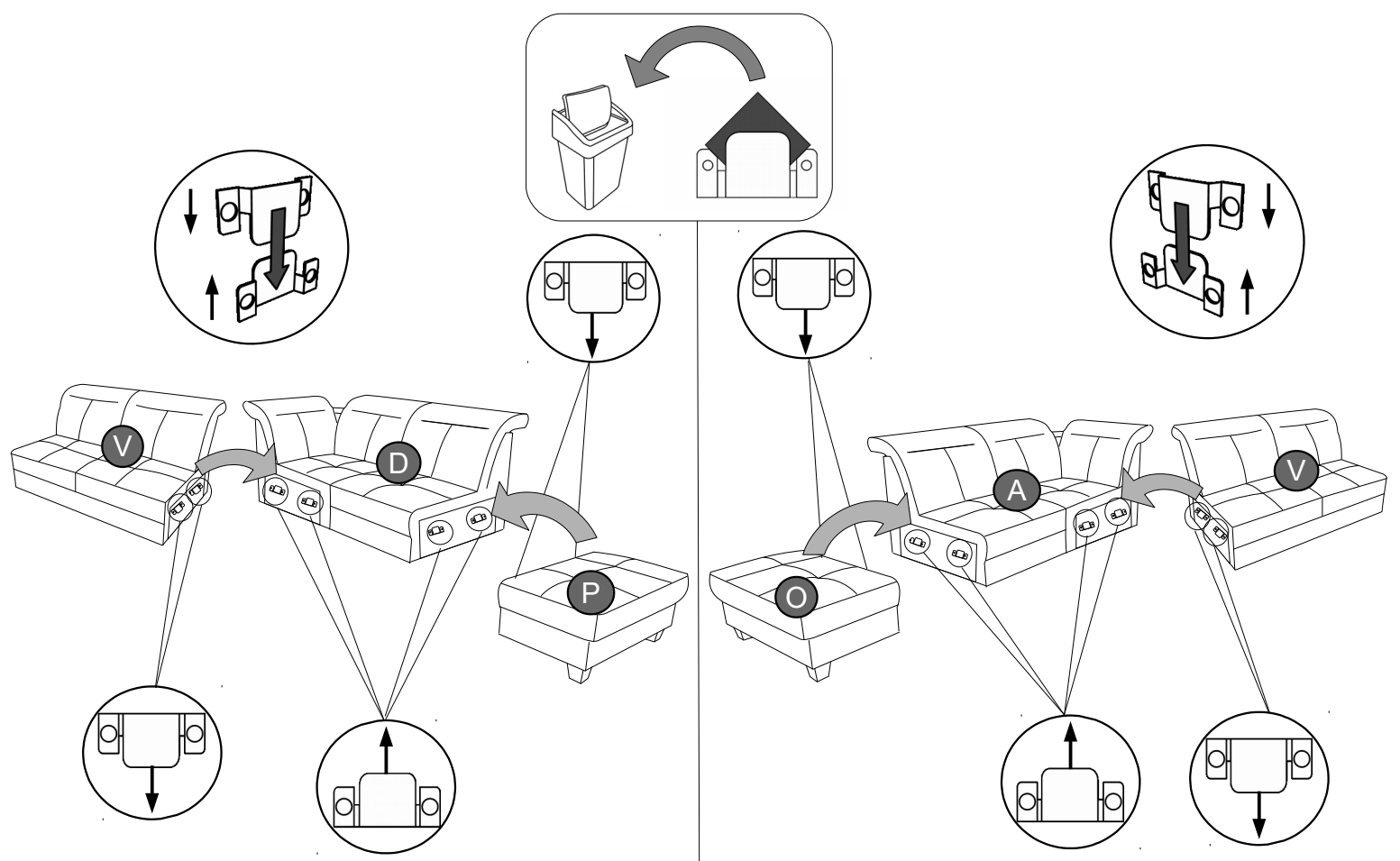

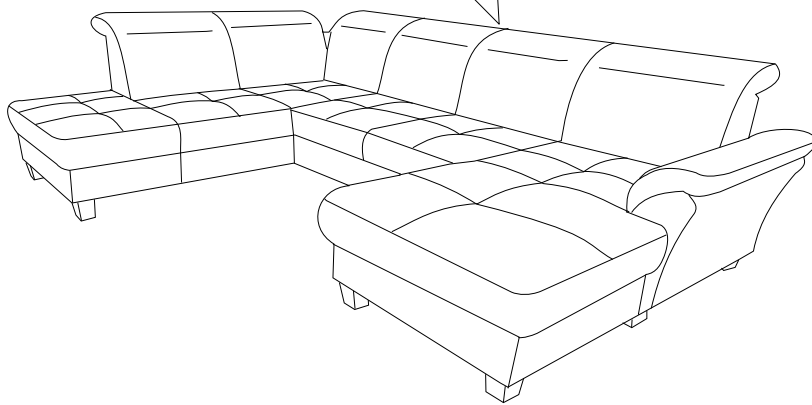
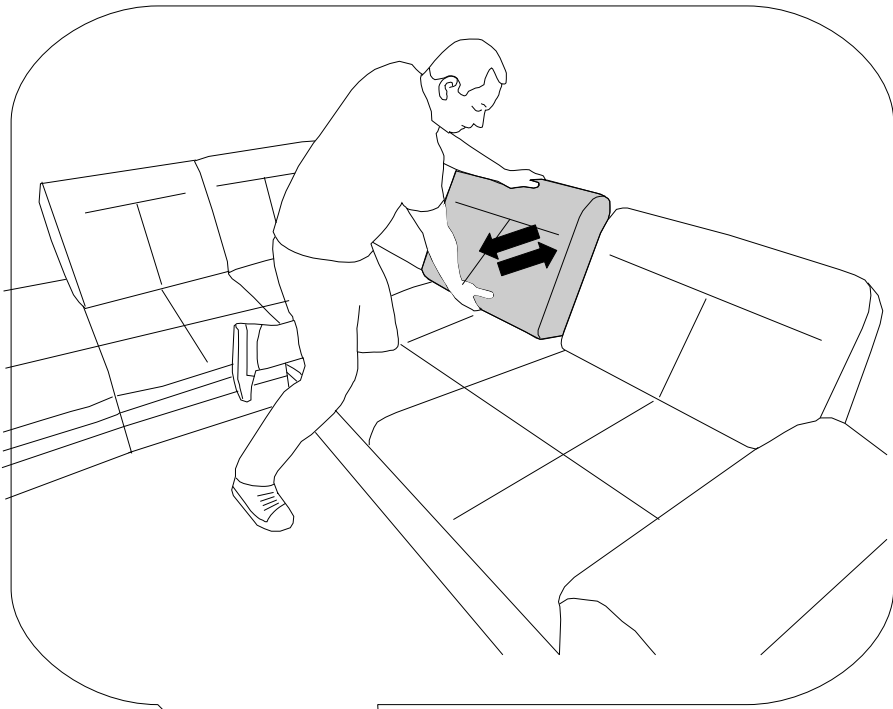

Name · Naam · Nazwa · İsim · Название · Nume · Nome · Názov · Názov ·
 Název · Neve

SOLVEI

Typ · Type · Tip · Тип · Tipo · Típus

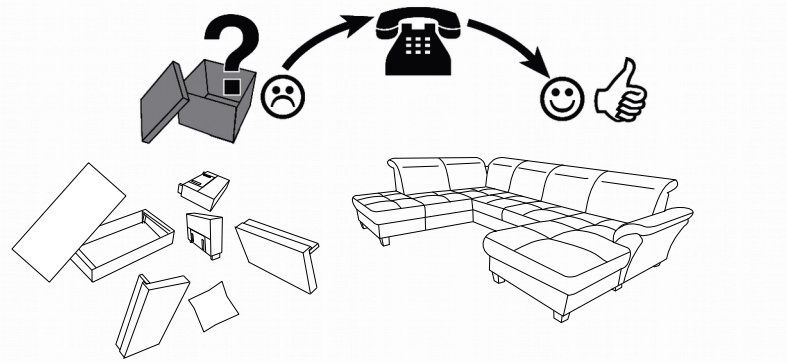
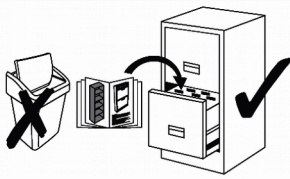
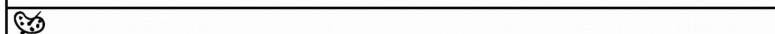

R

L

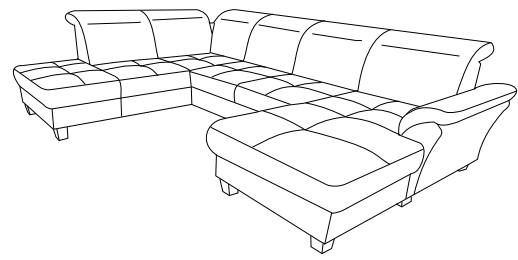
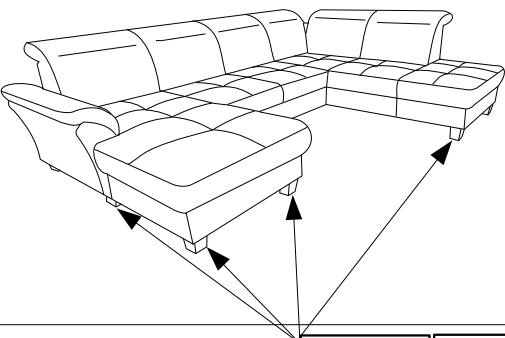

s H- 90	q M8*80	g H- 90	x Fi- 50 [mm]

